

Instructions for use

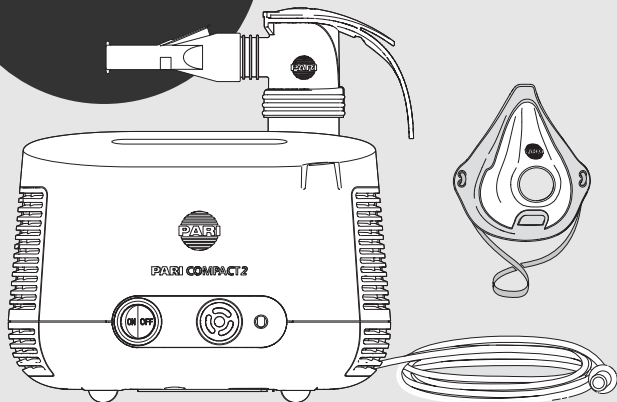

PARI COMPACT2 inhalation system

- Model: PARI COMPACT2 compressor (Type 152)
- Model: PARI LC SPRINT[®] COMPACT nebuliser (Type 023)
- Model: PARI mask soft (Type 041)
- PARI inhalation system for the therapy of the lower airways

Read the instructions for use

Read these instructions carefully before using the product. Follow all instructions and safety directions. Keep the instructions in a safe place.

Validity of instructions for use

PARI COMPACT2 Compressor (Type 152)

PARI LC SPRINT COMPACT Nebuliser (Type 023)

PARI Mask soft (Type 041)

Contact

Email: info@pari.de

Tel.: +49 (0)8151-279 220 (international)

+49 (0)8151-279 279 (German)

Copyright

©2026 PARI GmbH Spezialisten für effektive Inhalation

Moosstr. 3, 82319 Starnberg, GERMANY. Technical and design changes and printing errors reserved. The same applies to illustrations.

Disclaimer

These instructions for use describe the components of PARI products and optional accessories. For this reason, these instructions for use also describe and illustrate features not present in your PARI product because they are, for instance, country-specific and/or optional. When using the systems, products and functions, the applicable country-specific regulations must be observed.

Trade marks

Registered trade marks of PARI GmbH Spezialisten für effektive Inhalation in Germany and/or other countries:

LC SPRINT[®], PARI[®]

Warranty

The PARI compressor comes with a 2-year warranty. The warranty period commences on the date of purchase.

TABLE OF CONTENTS

IMPORTANT INFORMATION	4
Intended purpose.....	4
Indication.....	5
Contraindication.....	5
Labelling.....	5
Safety and warning instructions.....	7
PRODUCT DESCRIPTION	11
Components.....	11
Overview and designations.....	11
Working parts.....	12
Description of function.....	13
Material information.....	14
Maintenance.....	14
Service life.....	15
USE	15
Setting up the compressor.....	16
Preparing for treatment.....	17
Performing treatment.....	20
Ending the treatment.....	22
Storage.....	22
REPROCESSING	22
Reprocessing cycles.....	24
Limits of reprocessing.....	25
Preparation for reprocessing.....	26
Reprocessing of nebuliser and mask.....	27
Reprocessing the compressor.....	30
Reprocessing the connection tubing.....	32
Further information about reprocessing.....	33
TROUBLESHOOTING	34
TECHNICAL DATA	35
Compressor.....	35
Nebuliser.....	37
FURTHER INFORMATION	39
Disposal.....	39
Links.....	39

1 IMPORTANT INFORMATION

1.1 Intended purpose

The PARI inhalation system consists of a PARI compressor, a PARI nebuliser and PARI accessories. The system is used to treat the lower airways.

This product can be used in a home environment, as well as in professional health institutions. Aside from the compressor, if used in a home environment, the product components may only be used by a single patient (no patient change). In a professional environment, the device can be used with different patients as long as the corresponding hygiene reprocessing measures are complied with.

This product must be used only by individuals who understand the contents of the instructions for use and are able to use the product safely.

Individuals in the following groups must be supervised by a person who is responsible for their safety:

- Babies, infants, and children
- Individuals with limited capabilities (e.g. physical, mental, sensory)

If the patient is not able to use this product safely on their own, then the treatment must be carried out by the responsible person.

This PARI product is suitable only for patients who are able to breathe by themselves and are conscious.

The frequency and duration of use is determined by professional medical staff¹ according to the individual needs of the patient.

Compressor

The purpose of the PARI compressor is to generate compressed air for operating a PARI nebuliser. The PARI compressor must be used only for PARI nebulisers. It can be operated by the patient themselves and must only be used indoors.

Nebuliser

The PARI LC SPRINT COMPACT nebuliser generates an inhalable aerosol² for inhalation for the therapy of the lower airways.

Together with a PARI compressor or the PARI CENTRAL and with PARI accessories, the nebuliser forms an inhalation system.

The nebuliser is suitable for use in treating patients in all age groups.

Only solutions and suspensions that are approved for use in nebuliser treatment may be used.

1) Professional medical staff: Doctors, pharmacists, and physiotherapists.

2) Aerosol: Small particles of solid, liquid or mixed composition (fine "mist") suspended in gases or air.

The nebuliser must only be connected with a PARI compressor or with a central gas supply system. The PARI CENTRAL is intended for the connection with the central gas supply system.

An application takes approximately 5 to 10 minutes (depending on the quantity of fluid), but in any case no more than 20 minutes.

Mask

The PARI mask soft is an accessory for inhalation treatment. That enables inhalation of aerosol² through the mouth and nose.

The different mask sizes are suitable for treating patients in the following age groups:

– PARI adult mask soft: Adults

The specified ages are approximate. The actual size of the mask depends on the size and shape of the person's face.

The mask must be used only with PARI nebulisers.

1.2 Indication

For treatment of diseases of the lower airways.

Masks

For patients who cannot inhale using a mouthpiece, or if inhalation via mask is preferred.

The mask forms a system with a nebuliser. The indication for this system is the same as the indication for the nebuliser used.







1.3 Contraindication



















Compressor, nebuliser and mask

There are no contraindications known to PARI GmbH.

1.4 Labelling

The following symbols can be found on the product and/or the packaging:

	Medical device
	Unique Device Identifier (UDI)
	Legal manufacturer
	Date of manufacture
	Serial number
	Item no.

	Production batch number, lot number
	This product conforms to the EU Medical Device Regulation 2017/745.
	Consult instructions for use
IP21	Degree of protection in accordance with EN 60529 against the ingress of solid foreign bodies and dripping water.
	Humidity limit
	Atmospheric pressure limit
	Degree of protection of the application component: Type BF
	Protection class II appliance
	Temperature limit
	Alternating current
	The medical device was distributed commercially after 13 August 2005. The product must not be disposed of with normal domestic waste. The symbol of the refuse bin with a cross through it indicates that it must be disposed of separately.
ON OFF	On/Off
	PARI COMPACT2 compressor
	Air filter for compressor type 152
	PARI adult mask soft
	Elastic band
	Mask stabiliser
	PARI LC SPRINT nebuliser with nozzle attachment
	Connection tubing
	Mouthpiece with exhalation valve

1.5 Safety and warning instructions

The present instructions for use contain important information, safety instructions and precautionary measures. The user must follow these in order to guarantee safe operation of this PARI product.

This PARI product must be used only as described in these instructions for use.

The instructions for use of the inhalation solution used must also be followed.

Labelling and classification of warning instructions

In these instructions for use, safety-critical warnings are categorised according to the following hazard levels:

DANGER

DANGER indicates a hazardous situation which will lead to very severe injuries or death if it is not avoided.

WARNING

WARNING indicates a hazardous situation which can lead to very severe injuries or death if it is not avoided.

CAUTION

CAUTION indicates a hazardous situation which can lead to mild or moderate injuries if it is not avoided.

NOTE

NOTE indicates a hazardous situation which can lead to material damage if it is not avoided.

General

If non-approved solutions or suspensions are used for nebulisation, then nebuliser aerosol characteristics may differ from the information provided by the manufacturer.

This product is not suitable for use in an anaesthetic breathing system or a ventilator breathing system.

Tracheotomised patients cannot inhale using a mouthpiece. To perform inhalation therapy, they require specific equipment. In this case, please contact your doctor for further information.

Skin care products containing oils or fats can damage the soft plastic components. The patient should refrain from using skin care products of this kind while using the device.

If your health condition does not improve or it even worsens as a result of the treatment, seek professional medical advice.³

Life-threatening situation from electrocution



DANGER

Life-threatening situation from electrocution

The compressor is an electrical device powered by mains voltage. It has been designed so that no live parts are accessible. However, in unfavourable ambient conditions, or if the compressor or power cord is damaged, this protection may no longer be provided. There may then be a risk of contact with live parts. This in turn may lead to an electric shock.

• To avoid this danger, comply with the following instructions:

- Every time before use, make sure that the compressor housing, the power cord and the power plug are undamaged. The compressor must not be operated
 - if the housing, the power cord or the power plug is damaged,
 - if a fault is suspected following a fall or similar.
- Never leave the compressor unattended while it is in use.
- Plug the compressor into an easily accessible socket. It should be possible to quickly unplug the power plug at all times.
- Switch the compressor off and disconnect the power plug from the mains socket immediately:
 - if it is suspected that the compressor or the power cord might have been damaged (e.g. after the compressor has fallen, or if there is a smell of burning plastic)
 - if a malfunction occurs during operation
 - before cleaning and maintaining the device
 - immediately after use
- Keep the power cord away from domestic animals (e.g. rodents). They may damage the insulation on the power cord.

3) Professional medical staff: Doctors, pharmacists, and physiotherapists.

Danger of a device defect

To avoid a device defect, comply with the following instructions:

- Make sure that the local supply voltage and frequency match the details marked on the compressor identification label.
- To disconnect the compressor from the socket, always pull the power cord out by the power plug, not the cable.
- Make sure that the power cord is never kinked, pinched or jammed. Do not pull the power cord over sharp edges.
- Keep the compressor and the power cord away from hot surfaces (e.g. stove top, electric fire, open fire). Direct heat may damage the compressor housing or the insulation on the power cord.

Treatment of babies, infants, and anyone who requires assistance



DANGER

Life-threatening situation from strangulation

For individuals who are not able to perform the therapy session without assistance or cannot appreciate the hazards, the risk of injury is greater e.g., strangulation with the power cord or the connection tubing. Such individuals include, for example, babies, children, and people with limited capabilities.

- Ensure that for these individuals a person responsible for their safety either supervises or implements the application.

Hazard due to small parts which can be swallowed



WARNING

Choking hazard from blocked airways

The product contains small parts. Small parts can block the airways and lead to a choking hazard.

- Keep all components of the product out of the reach of babies and infants at all times.

Impairment of treatment due to electromagnetic interference



CAUTION

Quality of treatment impaired by electromagnetic interference

The use of third-party products can result in higher levels of electromagnetic emissions or lower the resistance of the PARI device to electromagnetic interference.

- Use only original spare parts and original accessories from PARI.

Impairment of the therapy by disregarding the reprocessing instructions



Impairment of the therapy

Exceeding the reprocessing instructions can result in damage to the product. This can impair the therapy.

Falling short of the instructions can result in insufficient reprocessing. This can increase the risk of infection.

- Comply with the instructions about the reprocessing limits, temperature, holding time, and concentration of the chemical used.

Reporting serious incidents

Report serious adverse incidents to the manufacturer and to the competent authority.

Modifications to the device



Modifications to the device

If modifications are made to the device, safe and proper operation of the device cannot be guaranteed. An electric shock or overheating may occur.

- Do not make any modifications to the device.

2 PRODUCT DESCRIPTION

2.1 Components

The product components included in the scope of delivery are country-specific, and the contents may deviate from the components described in this instruction for use. For the scope of delivery, therefore please refer to the packaging.

2.2 Overview and designations

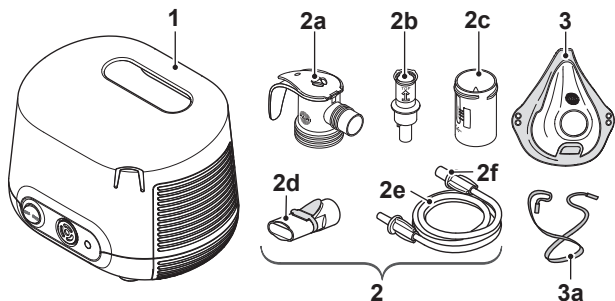

1	Compressor
2	Nebuliser
2a	Nebuliser top ⁴
2b	Nozzle insert ⁴
2c	Nebuliser lower part ⁴
2d	Mouthpiece ⁴ (with exhalation valve)
2e	Connection tubing ⁵
2f	Tubing connection ⁵
3	Mask⁴
3a	Elastic band

4) Applied part

5) Accessible part

2.3 Working parts

The compressor includes the following working parts:

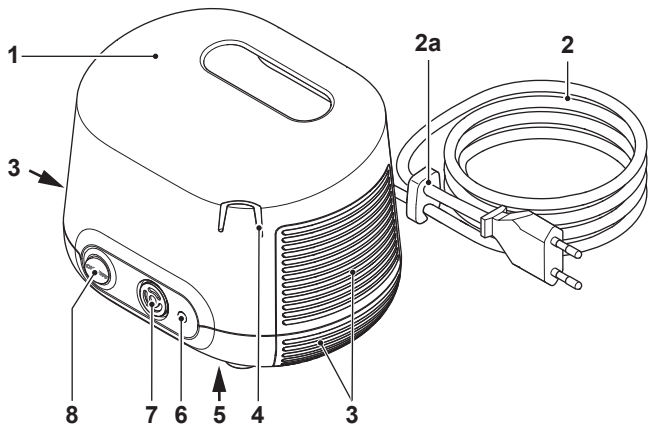

1	Carrying handle
2	Power cord ⁶ (connected inseparably to the compressor)
2a	Cable holder
3	Ventilation slits
4	Holder for nebuliser
5	Identification label (bottom of device)
6	Compressed air connection
7	Air filter
8	On/off switch

6) The power plug type is country-specific. The figure shows the europlug (type "C").

2.4 Description of function

Inhalation therapy (compressor with nebuliser and mouthpiece or mask)

Compressor and nebuliser

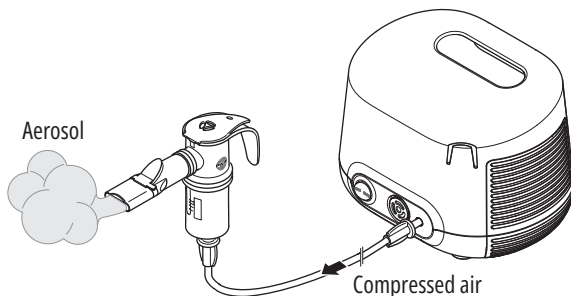

The compressor supplies the nebuliser with compressed air. When compressed air is supplied, the nebuliser generates an aerosol from the liquid, for example the medication with which it is filled. This aerosol is breathed into the lungs through the mouthpiece or optionally a mask.

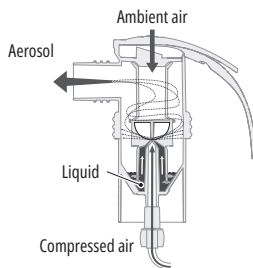

In combination with a mouthpiece or a suitable mask, the PARI LC SPRINT nebuliser is suitable for patients of all ages. The nozzle inserts described below are particularly suitable for the specified age groups.

The size of the aerosol droplets is determined by the nozzle inserts. The smaller the droplets are, the farther they can penetrate into the deeper and smaller regions of the lung:

– The orange nozzle insert creates tiny droplets to treat the lower airways in all age groups.

Mask

The mask is an accessory for PARI inhalation systems.

The mask makes it possible to inhale aerosol through the mouth and the nose.

The patient can breathe out through the aperture or the exhalation valve at the bottom end of the mask without having to take the mask off.

Use the elastic band affixed to the side openings of the mask to secure the mask in position on the face.

2.5 Material information

The individual product components are made from the following materials:

Compressor

Product component	Material
Compressor housing (upper and lower shell)	Acrylonitrile butadiene styrene

Nebuliser

Product component	Material
Nebuliser upper part	Polypropylene, thermoplastic elastomer
Nozzle attachment	Polypropylene
Nebuliser lower part	Polypropylene, thermoplastic elastomer
Mouthpiece (with exhalation valve)	Polypropylene, thermoplastic elastomer
Connection tubing	Polyvinyl chloride
Tubing adapter	Polyamide
Tubing connector	Thermoplastic elastomer

Mask

Product component	Material
PARI mask soft	Polypropylene, thermoplastic elastomer
Elastic band	Synthetic rubber

2.6 Maintenance

The compressor is maintenance free.

2.7 Service life

The individual product components have the following expected lifetimes:

Product component	Service life
Compressor	Approximately 500 operating hours (this corresponds to max. 3 years) If the compressor is still in use after this time, have it tested. To do this, contact the manufacturer or distributor.
Nebuliser, PARI mask soft, tubing adapter, connection tubing und accessory	Home environment [see: Limits of reprocessing in a home environment, page 25]
Nebuliser, PARI mask soft, tubing adapter, connection tubing und accessory	Professional environment [see: Limits of reprocessing in a professional healthcare institution, page 26]

When the expected operating life has been reached, replace the affected component. Replacement sets or PARI Year Packs (a nebuliser with connection tubing and an air filter for a compressor) are available.

3 USE

All the steps described below must be carried out properly.

If the nebuliser is to be connected to a central medical gas supply system via a PARI CENTRAL, the instructions for use of the PARI CENTRAL must be followed.

Do not use product components unless they have been thoroughly cleaned and dried. Wash your hands thoroughly before every use. You must perform cleaning and disinfection before using the device for the first time.



WARNING

Danger of acute respiratory distress when the nebuliser is operated using oxygen

When the nebuliser is used with the PARI CENTRAL O2, acute respiratory distress can arise through an increased level of carbon dioxide in the blood.

COPD patients with exacerbation may develop acute respiratory distress as a result of treatment which uses oxygen.

- The PARI CENTRAL O2 is no longer sold.
- If you use a PARI CENTRAL O2 which is still on the market, perform the treatment using oxygen only after consultation with, and under the supervision of, a professional.

 **CAUTION**

Risk of injury due to burns

Some parts of the compressor that can be touched, including the connection tubing on the compressor, may become very hot during operation under certain circumstances.

- Make sure that the connection tubing is not kinked during use.
- Never cover the compressor while it is operating.
- Make sure that the ventilation slits on the compressor are not covered.
- Never operate the compressor while it is in a bag.
- Do not touch the parts on the compressor for longer than 1 second during operation.

3.1 Setting up the compressor

The space in which the compressor is operated must satisfy certain conditions [see: During operation, page 36]. Also note the following warnings before setting the compressor up:

 **DANGER**

Risk of fire due to a short circuit

A short circuit in the compressor can cause a fire. In order to reduce the risk of fire in such an event, follow the instructions below:

- Do not operate the compressor close to easily flammable objects such as curtains, tablecloths, or paper.
- Do not operate the compressor in areas where there is a risk of explosion or in the presence of gases promoting combustion (e.g. oxygen, nitrous oxide, flammable anaesthetics).

 **CAUTION**

Impairment to quality of treatment caused by electromagnetic interference

Electrical devices can cause electromagnetic interference. Interference can impair the function of the devices and thus also the effectiveness of the treatment.

- Do not place the device immediately beside or on top of other devices.
- Keep it at a minimum distance of 30 cm from portable wireless communication devices (including their accessories, such as antenna cables or external antennas).
- If the device must be operated immediately beside or on top of other devices, then all devices must be monitored to ensure that they are working properly.

 **CAUTION**

Danger of injury from falling compressor

A compressor placed in a poor position poses a risk of injury.

- Do not place the compressor above head height.
- Make sure that it cannot be pulled down by the power cord or the connection tube.
- Do not place the compressor on a soft surface such as a sofa, a bed or a tablecloth.

NOTE

Danger of device fault caused by dust

If the compressor is operated in a very dusty atmosphere, dust may collect inside the housing. This may cause a fault in the device.

- Do not operate the compressor on the floor, under the bed or in workshops.
- Operate the compressor only in a low-dust environment.

Set the compressor up as follows:

1. Place the compressor on a firm, flat, dust-free, dry surface.
2.  **CAUTION!** Route the power cord in so that it is not a tripping hazard and so that no one can become entangled in it. Poorly routed cable connections pose a risk of injury. Plug the power plug into a suitable socket.

3.2 Preparing for treatment

Assembling the nebuliser

 **CAUTION**

Risk of impaired treatment

Damaged components and/or an incorrectly assembled nebuliser may impair functioning of the nebuliser and thus treatment as well.

- Check all nebuliser components and the accessories before each use.
- Replace any broken, deformed or seriously discoloured parts.
- Follow the assembly instructions in these instructions for use.

1. Press the nozzle insert lightly onto the nozzle in the nebuliser lower part. The arrow on the nozzle insert must point upwards.
2. Place the nebuliser upper part on the nebuliser lower part and turn it clockwise to lock the two parts together.
3. Attach the connection tubing to the nebuliser.

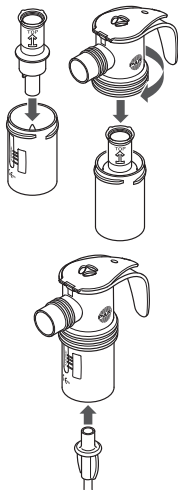

Preparing the inhalation therapy

USING THE MOUTHPIECE

1. Fit the mouthpiece onto the nebuliser.

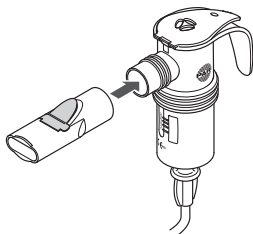

USING THE MASK

1. If necessary, attach the elastic band to the mask.
2. Attach the mask to the nebuliser.



When using the mask, ensure that the exhalation valve plate is pushed outwards, in order that you can exhale without obstruction during the inhalation process.

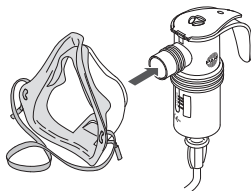
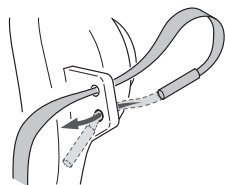

Filling the nebuliser

NOTE

Nebuliser lid might break off

If the cap is twisted in the wrong direction, it may break off. The nebuliser will then be unusable and irreparable.

- Never move the lid except in the direction allowed by the hinge.

1. Insert the nebuliser in the holder on the compressor intended for this purpose.
2. Open the nebuliser lid by pressing your thumb against the underside of the lid.
3. Pour the required quantity of inhalation solution into the top of the nebuliser.

Be sure to follow the instructions regarding the minimum and maximum fill volumes [see: General nebuliser data, page 37]. If the nebuliser contains too little or too much liquid, the nebulisation and consequently the therapy will be less effective.

4. Close the nebuliser lid. Make sure that the lid snaps into place.

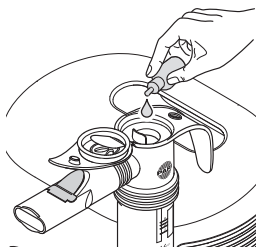

If several inhalation solutions are to be used one after the other:

1. Rinse the nebuliser out with drinking water between the individual applications.

2. Shake excess water out of the nebuliser.
3. Fill the nebuliser with the next inhalation solution as described.

3.3 Performing treatment

All the safety instructions and warnings in these instructions for use must have been read and understood before any treatment is carried out.

 *Always hold the nebuliser upright during treatment.*

1. If necessary, use the tubing adapter to connect the connection tubing and the compressor.
2. **⚠ DANGER! Life-threatening situation if tubes are mixed up!** If tubing systems for other devices are present close by (e.g., for infusions), check carefully to ensure that the other end of the connection tubing connected to the compressor is connected to the nebuliser. Otherwise, there is a danger that different connection options may be confused with each other.
3. Push the connection tubing of the nebuliser with a slight twist into the compressor's air connection.
4. Take the nebuliser out of its holder on the compressor and hold it upright.
5. Verify that all parts are firmly connected to each other.
6. **⚠ DANGER! Life-threatening situation from electrocution if there is a device fault!** Switch the compressor off immediately, and disconnect the power plug from the mains socket if a fault is suspected (e.g., if the device is dropped, or there is a smell of burning plastic). If there is a device fault, there may be a risk of contact with live parts. This in turn may lead to an electric shock. Switch the compressor on by shifting the on/off switch to "ON".
7. Check that an aerosol is being generated (a fine mist is escaping from the nebuliser) before you begin the therapy.

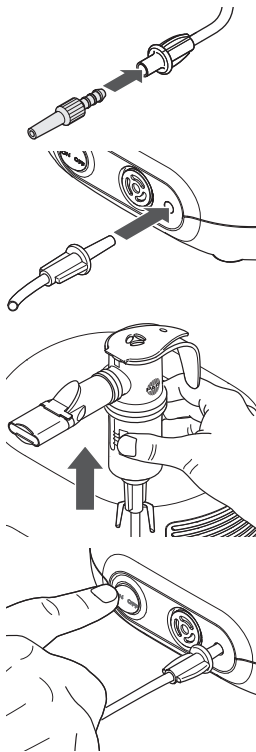

Inhalation therapy

INHALING WITH THE MOUTHPIECE

1. Sit in an upright position and relax.
2. Hold the mouthpiece between your teeth and enclose it with your lips.
3. Breathe in as slowly and deeply as possible through the mouthpiece, and out again calmly.
4. Carry out the inhalation treatment until the noise in the nebuliser changes.

 *Some residual fluid will remain in the nebuliser after the end of the treatment.*

INHALING WITH A MASK

CAUTION

Impaired treatment due to escaping aerosol

If the mask does not form a seal on the face, aerosol may escape. This may result in medication underdosage.

- Make sure that the mask completely covers both corners of the mouth and the nose.
- Take note of possible side effects caused by escaping aerosol. These are described in the information for use of the respective medication.

With PARI child or adult mask soft

1. Check whether the exhalation valve is pressed outwards, to ensure that the user can breathe out freely during the inhalation session.
2. Sit in an upright position and relax.
3. Use gentle pressure to place the mask tightly over mouth and nose.
Ensure that the nebuliser is positioned vertically.
4. If necessary, use the elastic band to hold the mask firmly in place against the face.
The elastic band runs along the back of the head.
5. Breathe in as slowly and deeply as possible through the mask, and out again calmly.
6. Carry out the inhalation treatment until no more aerosol is generated.

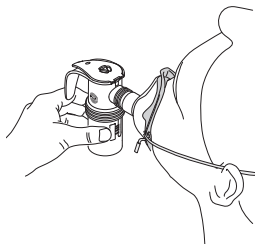
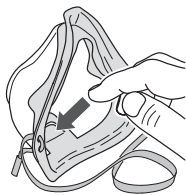

 *Some residual fluid will remain in the nebuliser after the end of the treatment.*

3.4 Ending the treatment

1. Switch the compressor off by shifting the on/off switch to "OFF".
2. Place the nebuliser back in the holder on the compressor.
3. Disconnect the power plug from the mains socket.

 *Complete disconnection from the mains is only certain when the power plug has been unplugged from the socket.*

3.5 Storage

After ending the treatment, store the compressor as described below:

 *When putting the compressor away, unplug the power plug from the socket. Electrical devices that remain plugged into the power supply present a potential hazard source.*

1. **NOTE!** Do not wind the power cord around the compressor. If the power cord is wound or bent very tightly, the wires inside the cord may break. The power cord will then be unusable.
Wind the power cord up loosely.
2. Secure the cable end in the cable holder.

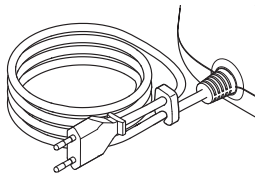

4 REPROCESSING

CAUTION

Risk of infection due to cross-contamination in the case of a change in patients

If a product is used for more than one patient, there is a risk that germs may be transmitted from one patient to the next.

- Clean, disinfect and sterilise all separated parts before every patient change.
- Replace the connection tubing or carry out mechanical cleaning and disinfection of the connection tubing [see: Reprocessing the connection tubing, page 32].

 **CAUTION**

Risk of infection due to growth of bacteria

Inadequate disinfection encourages the growth of bacteria and thus increases the risk of infection.

- During disinfection, comply with the specified holding time and the concentration of the chemical used.
- When using a disinfectant, ensure that the device is clean and operating properly. Allow the disinfection to continue until the disinfectant switches off automatically or the minimum disinfection time stated in the instructions for use of the disinfectant has elapsed. Do not switch the device off prematurely.

 **CAUTION**

Risk of infection by residual germs

If there is dirt on the parts, germs capable of reproduction may remain despite the sterilisation process. As a result, there is a danger of infection.

- Clean, disinfect, and dry all parts thoroughly before sterilising.
- Use only validated procedures for cleaning and disinfection.

 **CAUTION**

Risk of infection due to moisture

Moisture encourages the growth of bacteria.

- Ensure that the components are allowed to dry sufficiently after each processing step.

NOTE

Risk of damage to plastic parts!

Plastic melts if it comes into contact with hot surfaces.

- During thermal disinfection, you must ensure that the water level in the container is sufficient, in order that the individual parts do not come into contact with hot surfaces.

Always use drinking water for reprocessing in a home environment.

 *In professional health care institutions, drinking water is sufficient for precleaning. For all other reprocessing steps and processes, use deionised water with a low microbiological load (at least drinking water quality).*

Please observe the instructions for use for the chemicals used.
Wash your hands thoroughly before every reprocessing.

4.1 Reprocessing cycles

Perform the reprocessing steps as per the specified reprocessing cycles.

Reprocessing cycles in a home environment

Nebuliser components	– Clean immediately after every use – Disinfect once per week ⁷
Mask components	– Clean immediately after every use – Disinfect once per week ⁷
Elastic band	Cleaning visible dirt
Compressor housing	– Cleaning in the event of visible soiling and before each patient change – Disinfect by wiping before each patient change
Air filter	Replace after 200 operating hours (approx. 1 year) ⁸

Reprocessing cycles in professional healthcare institution

SINGLE PATIENT USE

Nebuliser components	– Clean immediately after every use – Disinfect once per week ⁷
Mask components	– Clean immediately after every use – Disinfect once per week ⁷
Elastic band	Cleaning visible dirt
Compressor housing	Cleaning visible dirt
Air filter	Replace after 200 operating hours (approx. 1 year) ⁸

7) For the therapy of patients at risk, disinfect the individual parts once per day. Take note of the additional information for patients at risk [see: Reprocessing for patients at risk, page 25].

8) Air filters are included in every PARI Year Pack.

BEFORE A CHANGE OF PATIENTS

Nebuliser components	– Cleaning – Disinfection – Sterilisation
Mask components	– Cleaning – Disinfection – Sterilisation
Connection tubing	Mechanical cleaning with disinfection
Elastic band	Replacing the elastic band
Compressor housing	– Cleaning – Wipe disinfection
Air filter	Replace after 200 operating hours (approx. 1 year) ⁸

Reprocessing for patients at risk



CAUTION

Danger of infection for patients at risk

For patients at risk, airway infections represent an increased risk of deterioration of general health, because these patients are particularly vulnerable to residual germs. Patients at risk include cystic fibrosis patients, patients with immunosuppression or immunodeficiency, and vulnerable patient groups.

- If you are a patient at risk, disinfect the individual parts once per day during the therapy.
- If you are unsure whether you are a patient at risk, consult with specialist medical personnel before use.

4.2 Limits of reprocessing

Limits of reprocessing in a home environment

Nebuliser and accessories, disinfection	300 processing cycles, max. 1 year
Mask, disinfection	300 processing cycles, max. 1 year

Limits of reprocessing in a professional healthcare institution

Nebuliser and accessories, disinfection	300 reprocessing cycles, max. 1 year
Nebuliser and accessories, sterilisation	100 processing cycles, max. 1 year
Connection tubing	50 reprocessing cycles, max. 1 year
Mask, disinfection	300 processing cycles, max. 1 year
Mask, sterilisation	100 processing cycles, max. 1 year

4.3 Preparation for reprocessing

Procedure	
Com-pressor	<ol style="list-style-type: none"> 1. Detach the connection tubing from the compressor.
Nebuliser	<ol style="list-style-type: none"> 1. Detach the connection tubing from the nebuliser. 2. Detach the mouthpiece from the nebuliser. 3. Make sure that all residual volume is removed from the nebuliser. 4. Dismantle the nebuliser into its individual parts.
	<ol style="list-style-type: none"> 1. Carefully pull the blue exhalation valve out of the slot in the mouthpiece. The exhalation valve must still be attached to the mouthpiece.
Mask	<ol style="list-style-type: none"> 1. Disconnect all mask components from the nebuliser. 2. Dismantle the mask into all its individual parts.

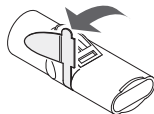



4.4 Reprocessing of nebuliser and mask

The following products can be cleaned, disinfected and sterilised according to the procedure described below:

- PARI nebuliser and PARI accessories
- PARI mask soft

The connection tubing and elastic band of the mask must be treated separately.

Procedure	
Step 1: Precleaning	<p>All individual parts must be precleaned immediately after use.</p> <p>EQUIPMENT:</p> <ul style="list-style-type: none">– Drinking water temperature of about 15 °C <p>PROCEDURE:</p> <ol style="list-style-type: none">1. Rinse all parts used for 2 minutes in running drinking water.
Home environment	<p>Step 2: Cleaning</p> <p>EQUIPMENT:</p> <ul style="list-style-type: none">– Drinking water temperature of about 40 °C– Standard commercial washing-up liquid– Container having sufficient capacity <p>PROCEDURE:</p> <ol style="list-style-type: none">1. Unless otherwise specified by the manufacturer of the washing-up liquid, add about 1 teaspoon of washing-up liquid to 3 l warm drinking water.  <ol style="list-style-type: none">1. Place all the parts in the washing-up water. Application time: 5 minutes2. Occasionally move the parts back and forth.3. In case of visible soiling, use a medium-soft brush (e.g. a toothbrush) which is used exclusively for this purpose. <p>RINSING:</p> <ol style="list-style-type: none">1. Rinse off all parts thoroughly in running drinking water at about 15 °C for 3 minutes. <p>Cleaning the elastic band</p> <ol style="list-style-type: none">1. Clean the elastic band as necessary with warm drinking water and a little dishwashing liquid. <hr/> <p> <i>The elastic band cannot be disinfected or sterilised.</i></p>

Procedure

Home environment	Step 3: Disinfection	<p>A - Thermal disinfection using boiling water</p> <p>EQUIPMENT:</p> <ul style="list-style-type: none">– Clean cooking pot– Drinking water <p>PROCEDURE:</p> <ol style="list-style-type: none">1. Place all the individual parts in water at a rolling boil for at least 5 minutes. <p>B - Using a standard thermal disinfectant for baby bottles</p> <p>EQUIPMENT:</p> <ul style="list-style-type: none">– Thermal disinfectant with a runtime of at least 6 minutes. <p>PROCEDURE:</p> <p>Regarding the performance of the disinfection, the duration of the disinfection procedure and the quantity of water required, follow the instructions for use of the disinfectant you are using.</p>
In professional health care institutions	Step 2: Cleaning and disinfection	<p>EQUIPMENT:</p> <ul style="list-style-type: none">– Neodisher® MediClean forte (concentration: 0.5%)– Deionised water– Cleaning and disinfection device as per ISO 15883. <p>PROCEDURE:</p> <ol style="list-style-type: none">1. Programme for cleaning and thermal disinfection (at least A0 = 3000) as per manufacturer's instructions.

Procedure

In professional health care institutions	Step 3: Sterilisation	<p>For sterilisation, use a process compliant with the ISO 17665 series of standards.</p> <p>PROCEDURE:</p> <p>Sterilisation temperature and holding time:</p> <ul style="list-style-type: none"> – Temperature: 134 °C – Holding time: minimum 3 minutes to maximum 5 minutes 	
		<p>Information on sterilising a PARI mask soft:</p> <p>Always use the corresponding mask stabiliser when sterilising this mask type, because otherwise the mask may lose its shape under the effects of high temperatures.</p>	
Drying	<p>Ensure that there is no residual moisture remaining in the components. If necessary:</p> <ol style="list-style-type: none"> 1. Shake the water out of all of the parts. 2. Place all parts on a dry, clean and absorbent surface and allow them to dry completely. 3. Using a standard thermal disinfecter for baby bottles: Leave all individual parts in the closed thermal disinfecter for max. 24 hours until the next use. 		
	Visual inspection	<p>Inspect all product components after each cleaning, disinfection or, where applicable, sterilisation. Replace defective, deformed or seriously discoloured parts.</p>	
Storage	<p>Store this product as described below:</p> <ul style="list-style-type: none"> – Dry and dust-free, e.g. in a clean, lint-free cloth (e.g. a tea towel) – Protected against contamination, where necessary (e.g. using optional sterile packaging) 		

4.5 Reprocessing the compressor



DANGER

Life-threatening situation from electrocution

Liquids can conduct electricity, thereby posing a risk of electric shock.

- Before starting to clean the compressor, always switch it off, and disconnect the power plug from the mains socket.

NOTE

Danger of device fault due to liquid penetration

If liquids get into the interior of the compressor, this may cause a fault in the device.

- Never immerse the compressor in water.
- Never clean the compressor in running water.
- Never spray any liquids onto the compressor or the power cord.
- If liquid gets into the compressor, it must not be used under any circumstances. Before starting the compressor again, contact the manufacturer or distributor.

Procedure

Step 1: Cleaning	<ol style="list-style-type: none">1. Wipe the outer surface of the housing with a clean, damp cloth.	
Step 2: Disinfection	<p>For disinfection, use a standard, alcohol-based disinfectant (e.g. isopropanol). When applying and dosing the disinfectant, it is essential to follow the instructions for use for the product.</p> <ol style="list-style-type: none">1. If the compressor is visibly dirty, clean the compressor before disinfecting it.2. Moisten a cloth with the disinfectant.3. Wipe the outer surface of the housing thoroughly with the cloth.4. Let the disinfectant dry completely.	

Procedure

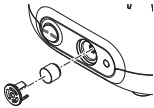
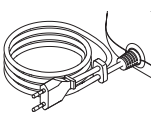
Visual inspection	<ol style="list-style-type: none">1. Inspect all product components after each cleaning and disinfection.2. Replace defective, deformed or seriously discoloured parts. <p>The air filter must be checked at regular intervals (after every 10th use). If it is discoloured brown or grey, or if it is damp or clogged, it must be replaced.</p> <p>The air filter cannot be cleaned and then reused!</p>	
	<p>Removing the air filter</p> <ol style="list-style-type: none">1. Pull the filter holder out of the compressor. Use a small screwdriver, for example, to prise the filter holder carefully out of the compressor.	
	<p>Replacing the air filter</p> <ol style="list-style-type: none">1. NOTE! For operating your compressor, use only air filters provided by the manufacturer or distributor. If air filters not designed for the compressor are used, it may be damaged. Pull the old air filter out of the filter holder, and fit the new filter in its place.2. Insert the filter holder back in the compressor.	
Storage	<ol style="list-style-type: none">1. ⚠ CAUTION! Electrical devices that remain plugged into the power supply present a potential hazard source. When putting the compressor away, unplug the power plug from the socket.	
	<ol style="list-style-type: none">1. NOTE! Do not wind the power cord around the compressor. If the power cord is wound or bent very tightly, the wires inside the cord may break. The power cord will then be unusable. Wind the power cord up loosely.2. Secure the cable end in the cable holder.3. Wrap all individual components in a clean, lint-free cloth (e.g. a tea towel).4. Store the product in a dry, dust-free place.	

4.6 Reprocessing the connection tubing

Dry the connection tubing after each use.

The maximum operating life of the connection tubing is 1 year.

Procedure	
In professional health institutions (during a patient change)	Cleaning and disinfection of machine
	<p>EQUIPMENT:</p> <p>The method has been validated in Europe using:</p> <ul style="list-style-type: none">– Neodisher® MediClean forte (concentration: 0.5%)– Deionised water– Cleaning and disinfection device as per ISO 15883.– Special baskets for Miele instrument dishwasher– Compressed air source for drying <p>PROCEDURE:</p> <ol style="list-style-type: none">1. Programme for cleaning and thermal disinfection (at least A0 = 3000) as per manufacturer's instructions.
Drying	<ol style="list-style-type: none">1. Connect the connection tubing to a compressed air source (compressor or central medical gas supply system).2. Switch the compressed air source on.3. Leave the compressed air source running until all the moisture in the tube has been removed.
Visual inspection	<ol style="list-style-type: none">1. Inspect all product components after each cleaning and disinfection.2. Replace defective, deformed or seriously discoloured parts.
Storage	<ol style="list-style-type: none">1. Store the product as described below:<ul style="list-style-type: none">– Dry and dust-free, e.g. in a clean, lint-free cloth (e.g. a tea towel)– Protected against contamination, where necessary (e.g. using optional sterile packaging)

4.7 Further information about reprocessing

Further validated processes for reprocessing

The instructions provided were validated by PARI and were found to be suitable for preparing your medical device for its reuse.



Further validated procedures for reprocessing:

https://www.pari.com/fileadmin/041D0624_Professional_healthcare_institution_Validated_Reprocessing_Methods.pdf

Ensure that the reprocessing actually performed by your personnel on your equipment with the chemicals used achieves the desired results. For this, validation and routine monitoring of the process are usually required. In particular, if you have to deviate from our validated process, ensure that the reprocessing method selected by you is appropriately effective, and that potential adverse effects are assessed.

5 TROUBLESHOOTING

The compressor must be repaired only by PARI GmbH Technical Service or a service location expressly authorised to do so by PARI GmbH. If the compressor is opened or manipulated by anyone else, all claims under the warranty shall be void. In these cases, PARI GmbH will accept no liability.

Contact the manufacturer or distributor:

- in the event of faults that are not listed in this chapter.
- if the suggested procedure does not correct the fault.

Fault	Possible cause	Remedy
The compressor does not start up.	The power plug is not plugged into the mains socket correctly.	Check whether the power plug is plugged into the socket correctly.
	The supply voltage is not suitable for running the compressor.	Check whether the local supply voltage matches the voltage data marked on the compressor identification label.
No aerosol is coming out of the nebuliser.	The nebuliser nozzle is blocked.	Clean the nebuliser.
	The connection tubing is not connected properly.	Check that the tubing connectors are connected firmly to the compressor and the nebuliser.
	The connection tubing is leaking.	Replace the connection tubing.

6 TECHNICAL DATA

6.1 Compressor

General compressor data

Supply voltage	220 – 240 V
Mains frequency	50 Hz
Power consumption	0.95 A
Housing dimensions (W × H × D)	18.5 cm × 13.0 cm × 15.0 cm
Weight	1.55 kg
Pressure ⁹	1.2 bar
Compressor flow ⁹	4.1 l/min.
Sound pressure level	56 dB(A)

Classification as per IEC 60601-1/EN 60601-1

Type of electric shock protection	Protection class II
Degree of protection from electric shock from the application component (nebuliser)	Type BF
Degree of protection against penetration by water and solid materials, as per IEC 60529/N 60529	IP 21
Degree of protection when used in the presence of flammable mixtures of anaesthetics with air, with oxygen, or with nitrous oxide	No protection
Operating mode	Continuous operation

9) Towards nebuliser nozzle (Ø 0.48 mm).

Electromagnetic compatibility

Electrical medical equipment is subject to special precautionary measures with regard to electromagnetic compatibility (EMC). Such equipment must be installed and operated only in accordance with the electromagnetic compatibility instructions.

Portable and mobile high-frequency communication devices can disrupt electrical medical equipment. Using accessories, converters and power cords other than those specified (with the exception of converters and power cords that the manufacturer of the medical electrical device sells as spare parts for internal components) can result in higher emission levels or reduce the device's resistance to interference.

The device must not be operated directly beside or on top of other devices. If the medical electrical device must be operated beside or on top of other devices, then it must be monitored to ensure that it is operating properly in the arrangement used.

On request, technical data on electromagnetic compatibility (EMC information) is available in table format from the manufacturer or distributor, or on the website [see: Links, page 39]

Ambient conditions

DURING OPERATION

Ambient temperature	+5 °C to +40 °C
Relative humidity	30% to 75% (non-condensing)
Atmospheric pressure	700 hPa to 1,060 hPa

The compressor is intended for operation in all healthcare situations. It is not permitted to operate it in trains, motor vehicles or aeroplanes. Use of the compressor in professional healthcare facilities is limited to the inpatient wards and the intensive care unit. Use of the compressor in areas with elevated magnetic or electrical radiation (e.g. close to an MRI scanner) is not permitted.

TRANSPORT AND STORAGE BETWEEN USES

Minimum ambient temperature (without monitoring of relative humidity)	-25 °C
Maximum ambient temperature (with relative humidity of up to 90%, non-condensing)	+70 °C
Humidity	max. 90%

6.2 Nebuliser

General nebuliser data

Size ¹⁰	10 cm × 10 cm × 4 cm
Weight ¹⁰	31 g to 33 g
Operating gases	Air, oxygen
Minimum compressor flow	3.0 l/min.
Minimum operating pressure	0.5 bar / 50 kPa
Maximum compressor flow	6.0 l/min.
Maximum operating pressure	2.0 bar / 200 kPa
Minimum fill volume	2 ml
Maximum fill volume	8 ml

Aerosol characteristics according to ISO 27427

The aerosol characteristics indicated in these instructions for use were determined according to ISO 27427 with a filling volume of 2.0 ml salbutamol. If other solutions or suspensions are used for nebulisation, the aerosol characteristics may differ from the values shown (particularly if they have greater viscosity).

The following data is based on tests according to a standard which takes adult breathing patterns as a basis. Therefore, these figures will probably differ from corresponding figures that were calculated for populations of children and infants.

10) Without mouthpiece and mask; unfilled.

Nozzle insert (orange)	Minimum compressor flow (3 l/min – 0.6 bar)	Nominal compressor flow (4.1 l/min – 1.2 bar) ¹¹	Maximum compressor flow (6 l/min – 1.9 bar)
MMAD [μm] ¹²	4.0	3.4	2.9
GSD ¹³	2.08	2.1	2.05
Respirable fraction [% < 5 μm]	61.7	68.7	76.5
Aerosol fraction [% < 2 μm]	17.4	24.9	28.6
Aerosol fraction [% > 2 μm < 5 μm]	44.3	43.8	47.9
Aerosol fraction [% > 5 μm]	38.3	31.3	23.5
Aerosol output [ml]	0.39	0.52	0.38
Aerosol output rate [ml/min]	0.05	0.15	0.16
Residual volume [ml] (gravimetric)	1.04	1.13	0.96
Percentage of fill volume emitted per minute [%/min]	2.7	8.0	7.9

11) Operation with PARI COMPACT2 compressor (Type 152).

12) MMAD = Mass Median Aerodynamic Diameter

13) GSD = Geometric Standard Deviation

7 FURTHER INFORMATION

7.1 Disposal

Compressor

This product falls within the scope of the European Council Directive on Waste Electrical and Electronic Equipment (WEEE)¹⁴. Accordingly, this product must not be disposed of with domestic waste. The disposal regulations applying in the respective countries must be complied with (e.g. disposal by local authorities or distributors). Materials recycling helps to reduce the consumption of raw materials and to protect the environment.

Nebuliser and mask

All product components may be disposed of with normal domestic waste. The country-specific disposal regulations must be observed.

7.2 Links



Terms and conditions of warranty:
<https://www.pari.com/int/warranty-conditions>



PARI inhalation systems in aircraft:
https://www.pari.com/fileadmin/041D0625_Airplane_Certificate_Jet_nebuliser.pdf



Technical data regarding electromagnetic compatibility:
<https://www.pari.com/fileadmin/041D0623-Electromagnetic-compatibility-EMV.pdf>

14) Directive 2012/19/EU of the EUROPEAN PARLIAMENT AND THE EUROPEAN COUNCIL of July 4, 2012 on waste electrical and electronic equipment.



PARI GmbH, Spezialisten für effektive Inhalation
Moosstr. 3, 82319 Starnberg, GERMANY
info@pari.de